

# alpha+

by ascott

a range of basic corrosion test cabinets  
from the company you can trust



# alpha+

by ascott

Easy to install – minimal number of external service connections



Simple to operate – intuitive touch screen interface



Reliable – uncomplicated design backed by 25 years manufacturing experience

# alpha+

a range of basic corrosion test cabinets  
from the company you can trust

**H Series**

H500 / H1000

**Saturated Humidity Cabinets**

**S Series**

S500 / S1000

**Salt Spray Cabinets for short-term tests\***

**SP Series**

SP500 / SP1000

**Salt Spray Cabinets for long-term tests\***



\* Ascott define short-term tests as those up to 240 hours duration. Tests beyond this duration are defined as long-term tests.

- A range of 6 saturated humidity and salt spray cabinets.
- Two sizes, with either 500 or 1000 Litre internal capacities (16.6 / 35.3 cu ft).
- Robust glass reinforced plastic (GRP) construction, a durable impact resistant material with strong chemical and corrosion resistant properties to ensure a long life.
- Fully transparent and seamless domed roof providing 360° visibility, self-supporting when open.
- SP salt spray cabinets equipped with an advanced control system featuring a peristaltic pump based salt water delivery system, coupled with a user adjustable precision speed controller, to ensure consistent salt fog fall-out rates during long-term unattended testing.

# alpha+



Easy to install – minimal number of external service connections



Simple to operate – intuitive touch screen interface



Reliable – uncomplicated design backed by 25 years manufacturing experience

## common design features

- Manufactured from a robust glass reinforced plastic (GRP) construction, combined with other non-corroding materials, to guarantee a trouble free long life.
- Visually striking, transparent domed roof providing unimpeded 360° viewing of the cabinet interior.
- Latching roof stay for ease of loading.
- Self-regenerating water trap seal, preventing salt fog escaping during operation.
- Ergonomically positioned menu driven touch screen controller for comfortable and intuitive control.
- Timed stop facility and hours run counter.
- Maximised cross-sectional load area, enabling a large number of samples to be tested at any one time, without compromising ergonomics.
- Supplied with complimentary corrosion proof sample holders.
- Internal base loading platform available as an optional accessory for large/heavy objects to be located in the base of the cabinet.



# alpha+

## basic corrosion test cabinets

**models:  
H500 & H1000 saturated humidity  
cabinets**



### key features

- Precise temperature controlled, high humidity environment. Water held in a sump located in the cabinet base, is heated by an immersion heater to generate water vapour.
- As water vapour evaporates, it saturates the cabinet atmosphere with moisture. Test samples in the cabinet, below the dew-point temperature of the saturated air, will develop surface condensation.
- By careful design the high humidity environment is achieved without the need for a circulation fan, which would otherwise have to endure the hostile, high humidity environment.
- Safety cut-outs ensure the immersion heater is automatically isolated if the water reservoir runs dry.
- User can program either a single set temperature, or automatically cycle the cabinet temperature between two different temperatures for user defined periods of time.
- Automatic filling and topping up of the humidity water reservoir if connected to a pressurised water supply.



# alpha+

## basic corrosion test cabinets

### models:

**S500 & S1000 salt spray cabinets**

**- the ideal choice for short term tests**



### key features

- Designed specifically for short-term tests (up to 240 hours duration).
- Cabinet heated by externally mounted heater mats, protecting them against damage from the corrosive climate inside the cabinet, also ensuring uniform heat distribution inside the cabinet.
- Heated bubble tower humidifies the compressed air en-route to the salt fog atomiser, in full compliance with international test standards.
- Bubble tower can be topped up with water automatically, or by hand via the manual filler port.
- Utilises the atomisers' venturi effect combined with the air pressure regulator and gauge to deliver a uniform and continuous fall-out of salt fog on to the samples under test.
- Supplied with a 90L external salt water solution tank, easier to fill and clean than an integral tank.
- The all plastic atomiser has an integral filter in addition to a filter on the reservoir feed pipe to prevent salt crystal build-up blocking the outlet nozzle and disrupting the test.
- Cabinets can be operated with a wet or dry base.
- Insulated non-transparent roof blanket, offering greater thermal efficiency available as an option.



# alpha+

## basic corrosion test cabinets

### models:

### SP500 & SP1000 salt spray cabinets - the ideal choice for long term tests

#### key features

- Designed specifically for long-terms tests (over 240 hours duration).
- Cabinet heated by externally mounted heater mats, protecting them against damage from the corrosive climate inside the cabinet, also ensuring uniform heat distribution inside the cabinet.
- Heated bubble tower humidifies the compressed air en-route to the salt fog atomiser, in full compliance with international test standards.
- Bubble tower can be topped up with water automatically, or by hand via the manual filler port.
- Supplied with a 90L external salt water solution tank, easier to fill and clean than an integral tank.
- Additional and larger capacity tanks available for reduced change-over time on long-term testing.
- The all plastic atomiser has an integral filter in addition to a filter on the reservoir feed pipe to prevent salt crystal build-up blocking the outlet nozzle and disrupting the test.
- Cabinets can be operated with a wet or dry base.
- Insulated non-transparent roof blanket, offering greater thermal efficiency available as an option.

#### ... plus the additional features:

- SP models are equipped with an advanced control system featuring a peristaltic pump based salt water delivery system, coupled with a user adjustable precision speed controller.
- Ensures consistent fall-out of salt spray / fog on to the test samples, over longer term duration tests (240+ hours of continuous salt spray testing) especially if such testing is unattended.



# alpha+

## installation requirements



Developed with ease of installation in mind, the Alpha+ features integral runners to enable a fork lift truck to lift the cabinet from behind.

Once transported, the cabinets are floor standing with lockable castors so that they can be manoeuvred into the test facility and positioned with ease.



A connection to an exhaust vent to atmospheric pressure and a low level waste water drain is required, to allow the combined exhaust and drain to remove waste water / salt water and fog from the cabinet.

All Alpha+ cabinets can be installed with minimal disruption in as little as 30 minutes.



## technical support

Ascott has a wealth of knowledge and highly experienced technical support staff, internally and externally amongst our many distributors. So wherever you are in the World we can help keep your Alpha+ test cabinet in excellent working condition.

## international standards compliance

The Alpha+ range complies with the most popular international standards for corrosion testing, including:

### *Salt spray standards*

ASTM B117  
ISO 9227  
DIN 50 021  
JIS Z 2371

### *Humidity standards*

DIN 50 017-KK  
DIN 50 017-KFW  
DIN 50 017-KTW  
ISO 6270-2  
VDA 621-421  
ASTM D2247  
BS 3900 Part F2

All cabinets are CE marked as your assurance of their quality and compliance with European directives.



# alpha+

## technical specifications

Product Details		H500	H1000	S500 & SP500	S1000 & SP1000
Workspace capacity	Ltrs (cu ft)	500 (17.6)	1000 (35.3)	500 (17.6)	1000 (35.3)
Workspace internal dimensions	width 'a' mm (inches)	1076 (42.4)	1553 (61.1)	1076 (42.4)	1553 (61.1)
	depth 'b' mm (inches)	683 (26.9)	863 (33.0)	683 (26.9)	863 (33.0)
	cabinet height 'c' mm (inches)	616 (24.3)	620 (24.4)	616 (24.3)	620 (24.4)
	roof height 'd' mm (inches)	250 (9.9)	350 (13.8)	250 (9.9)	350 (13.8)
	total height 'e' mm (inches)	866 (34.2)	970 (38.2)	866 (34.2)	970 (38.2)
Cabinet external dimensions	width 'f' mm (inches)	1650 (65.0)	2127 (83.7)	1650 (65.0)	2127 (83.7)
	depth 'g' mm (inches)	934 (36.8)	1127 (44.4)	934 (36.8)	1127 (44.4)
	height 'h' mm (inches)	1102 (43.4)	1159 (45.6)	1102 (43.4)	1159 (45.6)
Cabinet weight	kg (lbs)	130 (287)	190 (419)	130 (287)	190 (419)
Cabinet load capacity	kg (lbs)	80 (176)	150 (330)	80 (176)	150 (330)
Cabinet colour		White	White	White	White
Saline reservoir capacity	Ltrs (US gal)	n/a	n/a	90 (23)	90 (23)
Voltage <sup>#</sup>	Volts (50/60 Hz, 1 ph)	220-240	220-240	220-240	220-240
Max current <sup>##</sup>	Amps	10	10	10	10
Sample holders included	per cabinet	5	7	5	7
Slots*	per sample holder	30	38	30/24	38/32
Max number of test coupons**	per cabinet	150	266	144	260
Bubble tower temperature range	°C (°F)	n/a	n/a	Adjustable from ambient to +63 (+145)	
Cabinet temperature	- without insulated roof option	Adjustable from ambient plus 10 (50) to +55 (+131)		Adjustable from ambient to +35 (+95)	
	- with insulated roof option	n/a	n/a	Adjustable from ambient to +50 (+122)	
Salt fog fall-out rate	- without insulated roof option	n/a	n/a	Adjustable from 1.0 to 1.5	
	- with insulated roof option	n/a	n/a	Adjustable from 1.0 to 2.5	

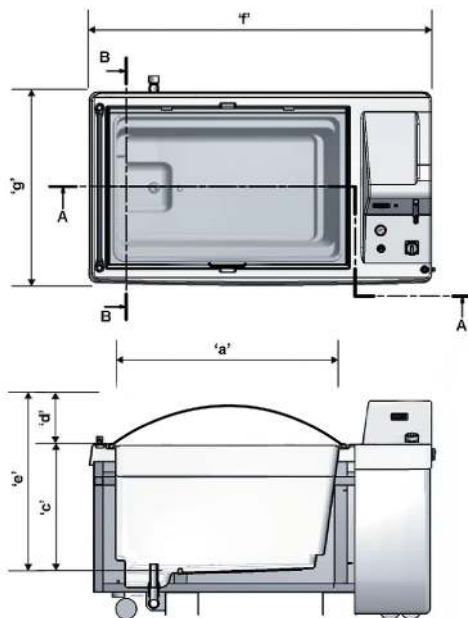

Section on A-A

# Other voltages available on request.







##For other voltages the current will vary.

\* Sample holders are pre-cut with 3mm (1/8inch) wide slots, angled 15 degrees from vertical, to accommodate test coupons - but will support other test samples as well. All but one of the holders can be removed. On the S & SP models one holder also supports the salt fog atomiser, and as a consequence has 6 fewer slots available for use.

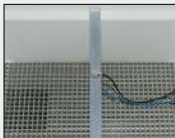







\*\*The maximum number of test coupons that can be accommodated assumes that all sample holders are fully loaded with test coupons of nominal dimensions; 100mm (4 inches) wide by 150mm (6 inches) high.

# alpha+

## optional accessories of all cabinets

	500 L 1000 L			
	Option reference			
Internal base loading platform	ACC15/8 ACC15/9	Horizontal removable loading platform, covering the internal base of cabinet, to enable large/heavy test samples to be accommodated directly on the internal base of the cabinet.		
Extra sample holders	ACC16/7 ACC16/8	Additional sample holders.	Internal base loading platform ACC15/8 , ACC15/9	
Rod type sample holders	ACC17/6 ACC17/7	For suspending small test samples hung beneath, or supporting larger test samples placed on top.		
Spiked type sample holders	ACC18/4 ACC18/5	For suspending test samples from 10mm/0.4" dia x 55mm/2" long spikes, equally spaced on both sides.	Extra sample holders ACC16/7, ACC16/8	
Transformer	ACC33	Converts the Alpha + cabinet to operate on 110 Volts.	Rod type sample holders ACC17/6, ACC17/7	
Height increase kit	ACC56	Kit of components for raising the height of a cabinet by 138mm ±10mm.		
Installation kit - S & SP cabinets	ACC22	A U-trap to connect between the drain outlet of cabinet and local drain facility, to prevent any smells from entering the cabinet via the drain. Also 3m of drain/exhaust tubing with a selection of couplers, and (for ACC22 only) 3m compressed air hose with hose clips.	Spiked type sample holders ACC18/4, ACC18/5	
Installation kit - H cabinets	ACC23		Transformer ACC33	
			Height increase kit ACC56	

## optional accessories for S & SP salt spray cabinet models

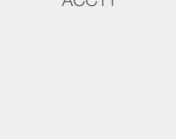
	500 L 1000 L			
	Option reference			
Fall-out measuring kit	ACC35	Two 80cm <sup>2</sup> funnels and two 0-100ml measuring cylinders, for monitoring salt spray fall-out rate.		
Hand-held salinity refractometer	ACC100 ACC100	A salinity refractometer to give a direct reading of percentage sodium chloride in water, in the range 0 to 28%, from a single drop of salt solution. Can be used to simply and accurately check the concentration of the salt solution to be sprayed.	Fall-out measuring kit ACC35	
Insulated roof blanket	ACC45/1 ACC45/2	An insulated non-transparent blanket for the transparent roof. Improves thermal efficiency to increase cabinet maximum operating temperature and salt spray fall-out range.		
Additional salt solution reservoir	ACC55	An additional 90Ltrs (23 US Gal) reservoir to the one supplied as standard.	Hand-held salinity refractometer ACC100	
Advanced salt solution reservoir	ACC02/* see note	Translucent salt solution tank with a graduated scale for viewing the contents, supplied with a hinged lid for filling & cleaning, mounted on castors. * ACC02/1 80 Ltr / 21 US gal capacity model * ACC02/2 115 Ltr / 30 US gal capacity model * ACC02/3 160 Ltr / 42 US gal capacity model		
Air compressor	ACC04/1	Provides continuous supply of oil free compressed air to enable functioning without connection to a local compressed air supply.	Insulated roof blanket ACC45/1, ACC45/2	
Deioniser	ACC06/* see note	Provides high purity water for making up salt solution and topping up the cabinet air saturator and humidity system. * ACC06/1 small model * ACC06/2 medium model * ACC06/3 large model		
Hand-held pH meter	ACC11	Digital pH meter, for measuring the pH of salt solution fallout over range 0-14 pH with a resolution of 0.01 pH.	Advanced salt solution reservoir ACC02	
Air agitation of salt solution	ACC96	Uses compressed air bubbles to aid dissolving salt within the salt solution reservoir to create a thoroughly mixed salt solution (only for use with ACC02 advanced salt solution reservoir).		
Peristaltic pump tube	PERC012	1m length of replacement peristaltic pump tube.	Air compressor ACC04/1	
Atomiser filters	SALC010	Pack of 5 replacement atomiser filters.	Deioniser ACC06	
			Hand-held pH meter ACC11	
			Air agitation of salt solution ACC96	

alpha+  
by ascott

A range of basic corrosion test cabinets  
from the company you can trust

## Other Ascott corrosion cabinets

The company also manufactures a range of Cyclic Corrosion Test (CCT) cabinets. Ascott CCT cabinets can be programmed to link together a variety of environments, in a sequence, which can be automatically cycled within the cabinet. This technique can be used to simulate naturally occurring corrosive conditions, which often combine synergistically to bring about a corrosion failure. Combining environments within a CCT cabinet produce more realistic corrosive conditions, than exposure to a single environment alone. This is a useful method for predicting service life expectancy, under laboratory conditions. For further information on cyclic corrosion cabinets contact Ascott.

All Ascott cabinets are CE marked.

It is the policy of Ascott Analytical Equipment Ltd to protect its products by means of patents and registered designs. The information contained herein was correct at time of going to press and is subject to change without notice.

© 2016 Ascott Analytical Equipment Ltd

Issue B

Local representative/supplier

### North American Office

Ascott Analytical Equipment  
37000 Plymouth Road  
Livonia, MI 48150, USA  
phone: +1 248 306 0394  
fax: +1 248 306 0396  
email: [info@ascott-analytical.com](mailto:info@ascott-analytical.com)  
web: [www.alpha--plus.com](http://www.alpha--plus.com)

### European Office

Ascott Analytical Equipment Limited  
6 - 8 Gerard, Lichfield Road Industrial Estate  
Tamworth, Staffordshire, B79 7UW, Great Britain  
phone: +44 (0) 1827 318040  
fax: +44 (0) 1827 318049  
email: [info@ascott-analytical.com](mailto:info@ascott-analytical.com)  
web: [www.alpha--plus.com](http://www.alpha--plus.com)

**alpha+**  
by **ascott**